

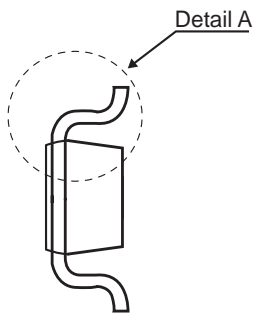

Package Outline Dimensions

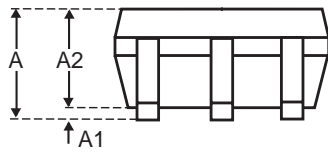

SYMBOLS	MILLIMETERS		
	Min.	Nom.	Max.
A	1.00	-	1.30
A1	0.00	-	0.15
A2	1.00	1.10	1.20
b	0.30	0.40	0.50
c	0.10	-	0.20
D	2.80	2.90	3.02
E	1.50	1.60	1.70
E1	2.60	2.80	3.00
e	0.90	0.95	1.00
e1	1.80	1.90	2.00
L	0.45	0.55	-
L1	0.30	-	0.60
	0°	-	10°

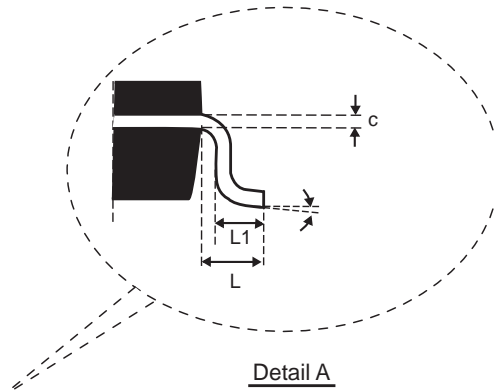
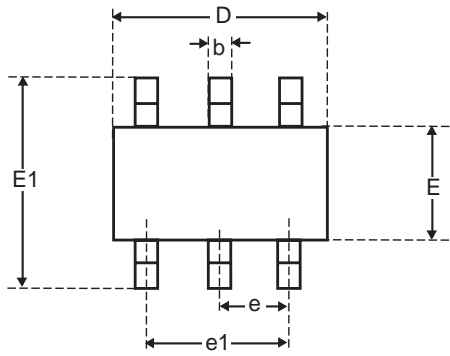

Carrier Tape & Reel Dimensions

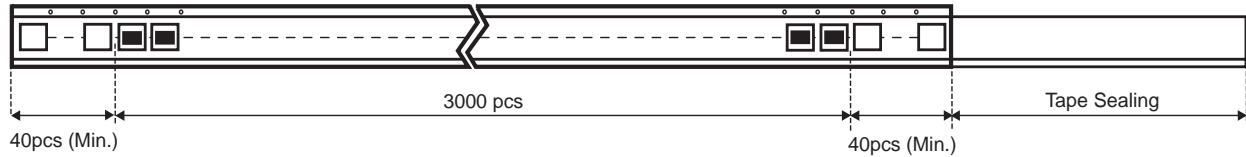
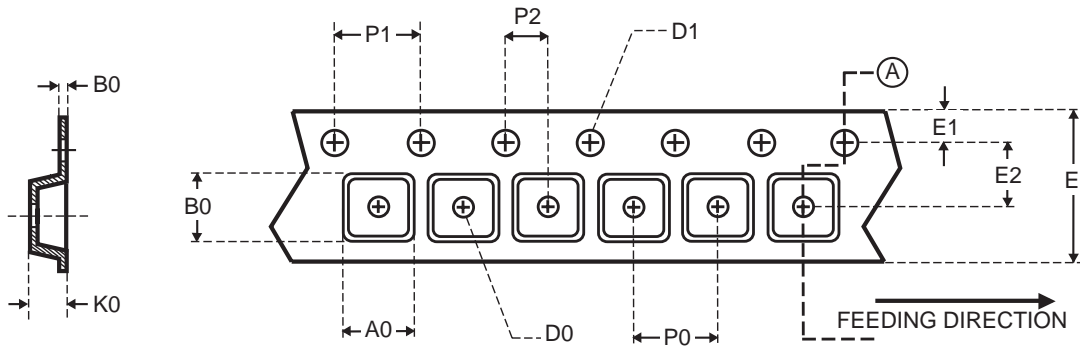

Package	A0	B0	K0	D0	D1	E	E1	E2	P0	P1	P2
SOT-23-6	3.20 ± 0.10	3.00 ± 0.10	1.33 ± 0.10	1.00 + 0.25	1.50 + 0.10	8.00 + 0.30 - 0.10	1.75 ± 0.10	3.50 ± 0.05	4.00 ± 0.10	4.00 ± 0.10	2.00 ± 0.05

UNIT : mm

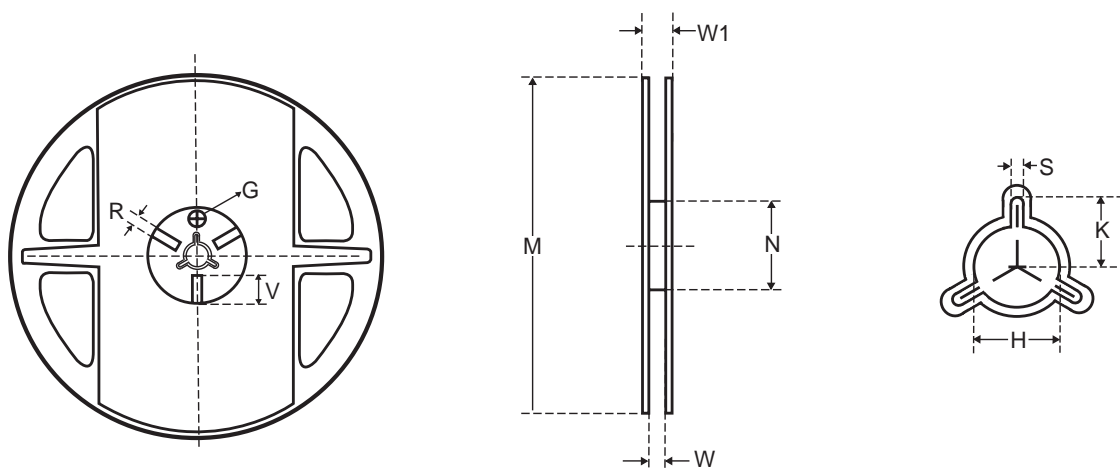

Tape size	Reel Size	M	N	W	W1	H	K	S	G	R	V
8mm	178	178 ± 1	60 ± 1	9.0 ± 0.5	12.0 ± 0.5	13.5 ± 0.5	10.5	2.0 ± 0.5	10.0	5.0	18.0

UNIT : mm